

**Inhalt**  
**Contents**  
**Contenu**

**Inhoud**  
**Contenido**  
**Conteúdo**

**Contenuto**  
**Содержание**  
**目录**

Einzelteilübersicht / Spare parts list / Liste des pièces détachées / Onderdelenoverzicht / Lista da piezas / Resumo de peça individual /  
Singoli componenti / Отдельные детали / 零件概览 ..... S./p./стр./ 页次 1

Montagetips / Tips for assembly / Tuyaux pour le montage / Montagetips / Consejos para el montaje / "Dicas" para montagem /  
Consigli per il montaggio / Советы по сборке / 装配建议 ..... S./p./стр./ 页次 2

Seite / Page / Page / Bladzijde / Página / Página /  
pagina / Страница / 页次 ..... 3

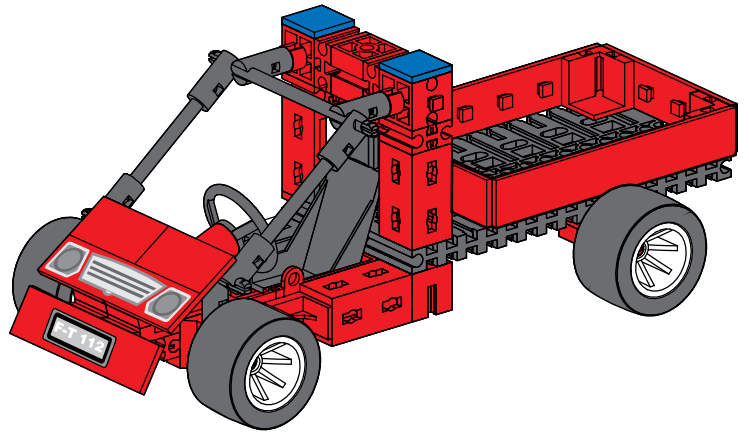

Seite / Page / Page / Bladzijde / Página / Página /  
pagina / Страница / 页次 ..... 7

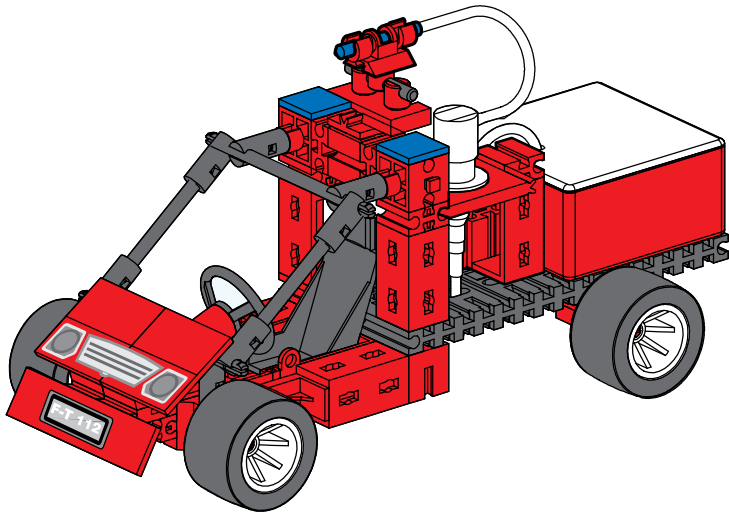



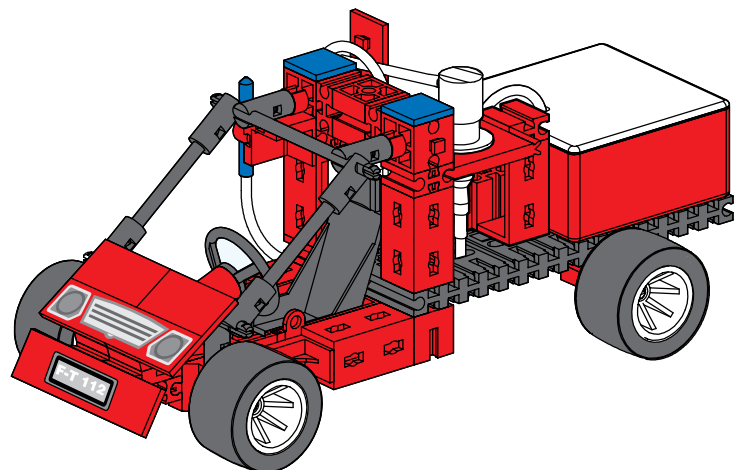









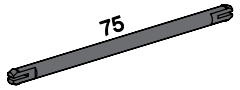



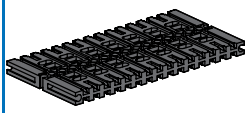
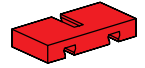



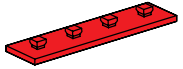



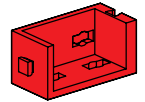

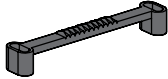
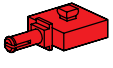

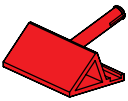



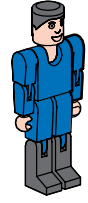

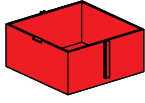





Seite / Page / Page / Bladzijde / Página / Página /  
pagina / Страница / 页次 ..... 9

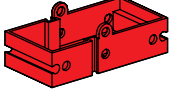

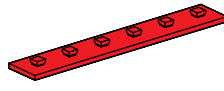
**Einzelteilübersicht**  
**Spare parts list**  
**Liste des pièces détachées**

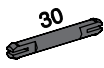
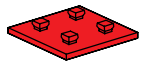
**Onderdelenoverzicht**  
**Lista da piezas**  
**Resumo de peça individual**

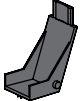
**Singoli componenti**  
**Отдельные детали**  
**零件概览**

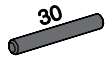
 30°	31 011 4 x		31 987 4 x	 75	35 087 2 x		38 423 2 x
 30	31 061 1 x		32 064 3 x		35 129 1 x		38 428 1 x
	31 124 1 x		32 078 2 x		35 980 3 x		38 464 3 x
	31 237 4 x		32 228 2 x		36 227 8 x		127 472 5 x
	31 426 1 x		32 229 1 x		36 586 2 x		130 770 1 x
	31 436 2 x		32 230 1 x		37 237 5 x		130 772 1 x
	31 632 1 x		32 853 1 x		37 468 8 x		130 961 1 x
	31 915 1 x				37 679 4 x		130 964 1 x
	31 916 1 x		32 881 2 x		38 240 8 x		130 966 1 x
	31 978 1 x		35 061 2 x		38 245 2 x		130 990 1 x
	31 982 11 x	 30	35 063 2 x		38 259 2 x		131 051 1 x
	31 984 1 x	 45	35 064 2 x	 30	38 413 1 x		

- Alle Einzelteile, insbesondere bewegliche Teile sind falls notwendig zu warten und zu reinigen.
- All components, especially moving parts, should be maintained and cleaned as necessary.
- Toutes les pièces détachées et en particulier les pièces mobiles, sont, si nécessaire, à entretenir et à nettoyer.
- Alle onderdelen, vooral de bewegende delen, kunnen, indien noodzakelijk, onderhouden en gereinigd worden.

- Es necesario limpiar y mantener en buen estado todas las diferentes piezas - especialmente las piezas móviles.
- Caso necessário, todas as peças individuais, especialmente peças móveis, tem que ser submetidas à manutenção e ser limpadas.
- Se necessario, tutti i singoli componenti, soprattutto le parti mobili, si devono eventualmente sottoporre a manutenzione e pulizia.
- Все детали, особенно подвижные, требуют ухода и чистки.
- 必要时应保养和清洁所有零件，尤指运动部件。